

Project Description

Throughout history, the formation behind libraries have continued to develop and change in the same way society has over the number of years. For this project, I explored the various components which make up the structure behind a library. Not only do they serve as a learning hub for the local community, but also act as a place for social gathering and digital exploration. Having been situated with the COVID crisis this has made a significant impact on the way social interactions are formed. People are no longer able to leave their homes and the mental health behind these individuals are beginning to deteriorate as the world fights this health crisis.

For this studio, I want to create a new method for helping people overcome their fear of the virus and to ultimately revive our social connections and interactions with one another. I plan to create a building which acknowledges a familiarised library structure but at the same time exposing the hidden elements which aren't necessarily seen by the public. These hidden elements are the digitised infrastructures (e.g. servers, data etc) and will be transformed into a new sustainable typology called a 'network of things'. These networks will essentially formulate into a new innovative strategy, inspired by the precedent of the 'Fabricance of Evidence' whereby the thermal performance of the technology will be re-directed into different areas of the building with the intention of creating innovative spaces such as a public library sauna and will be used to encourage the social interactions between others.

Precedents behind the project:

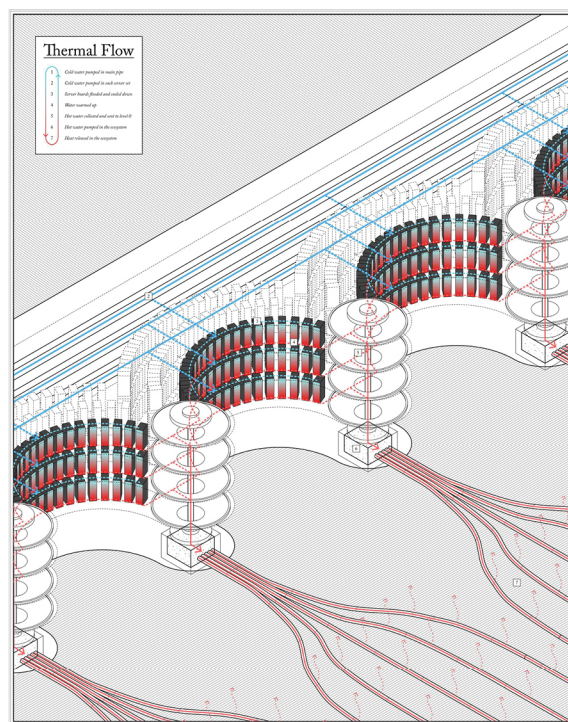
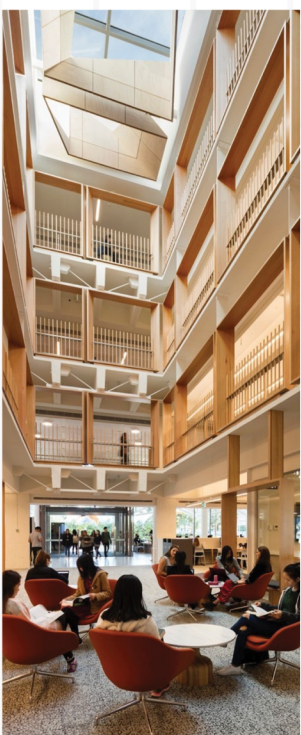

Creation of heat using Technology: Data Servers

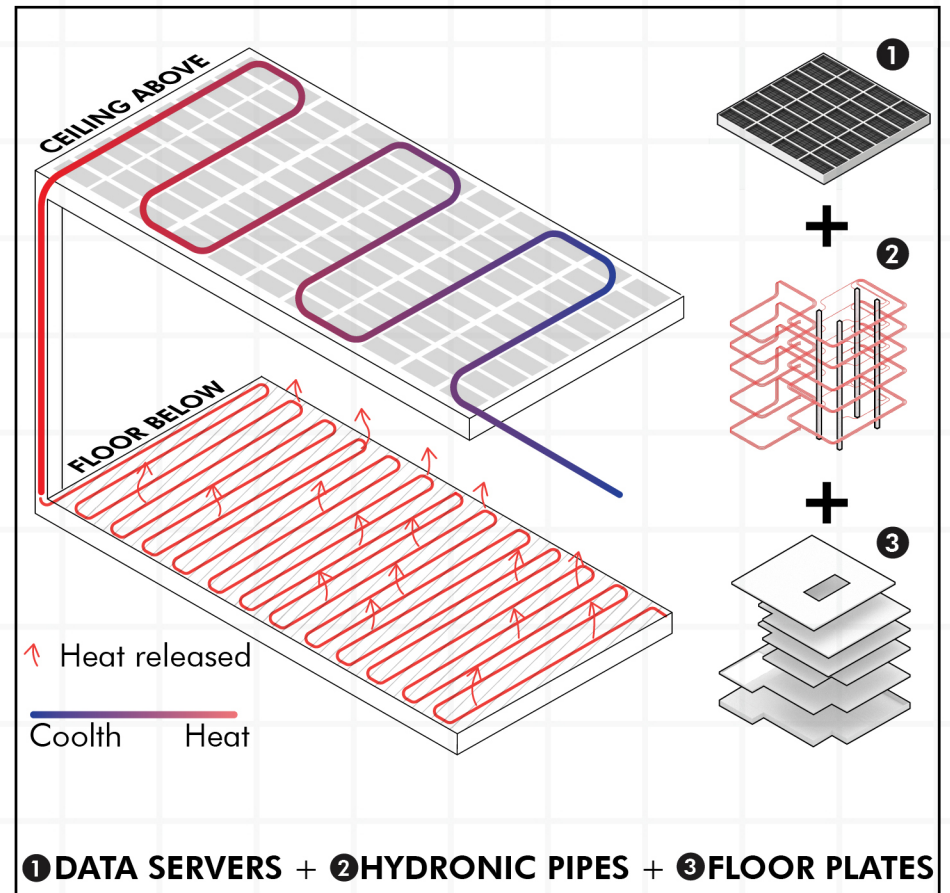

Creation of heat using Technology: Book-Bot

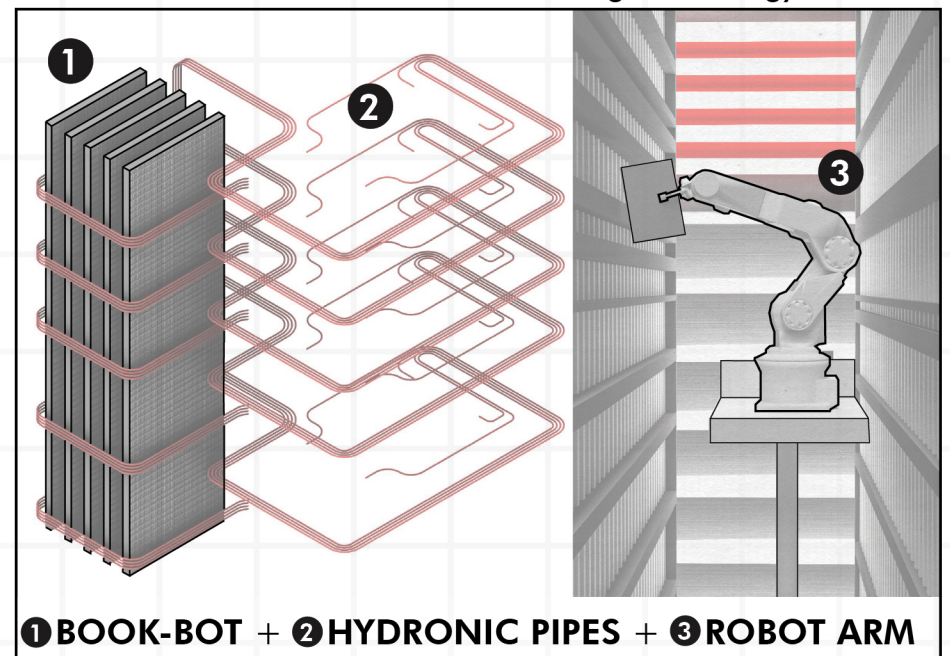

Protection of sunlight damage onto infrastructure:

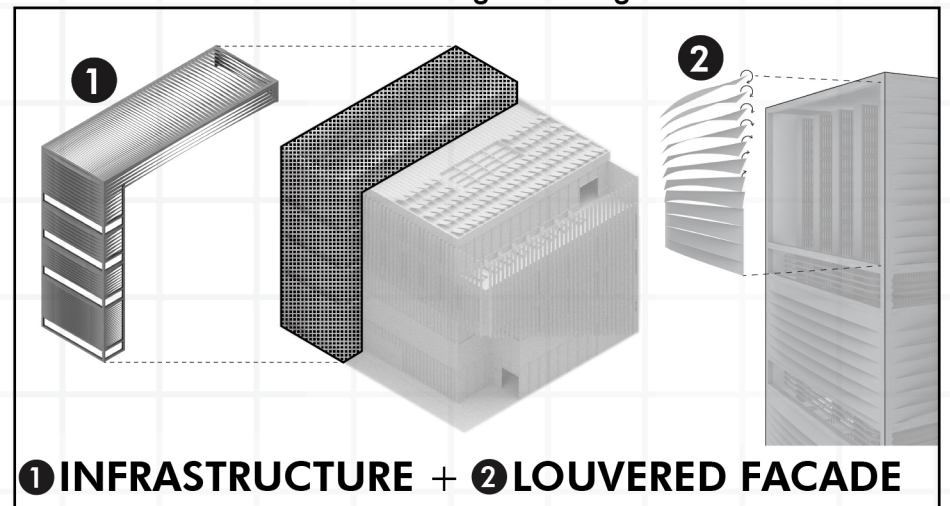

Generating electricity for the Technologies:

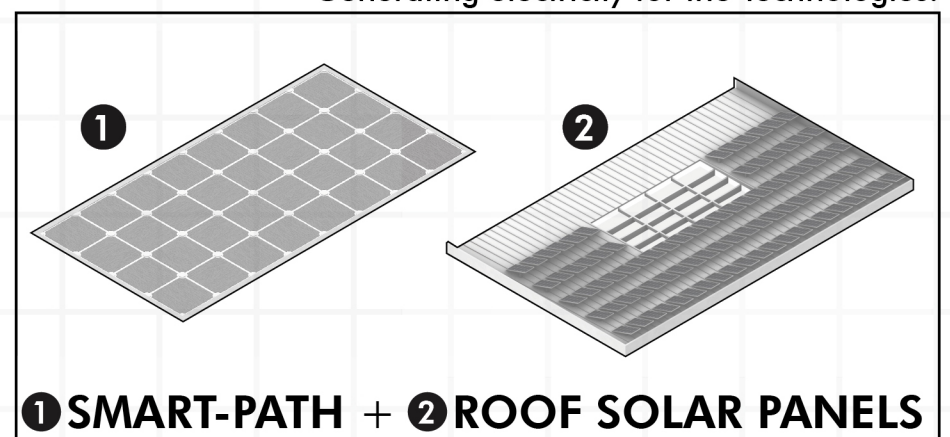

LIBRARY OF THE FUTURE

A NETWORK OF THINGS

02

PROPOSITION: LIBRARY IN THE CITY

Isometric - 1-500

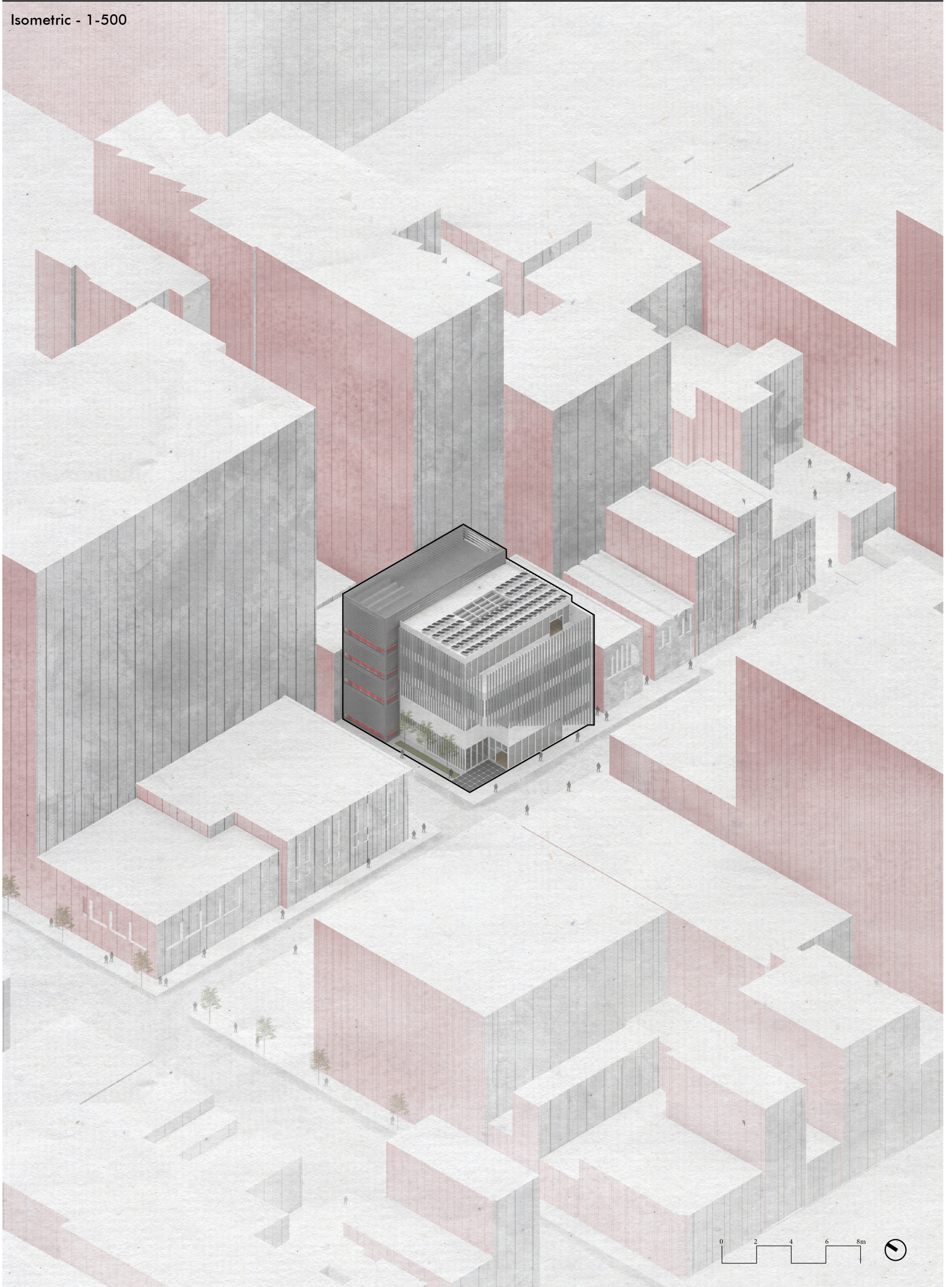

LIBRARY OF THE FUTURE

A NETWORK OF THINGS

03

PROPOSITION: LIBRARY AS A CITY

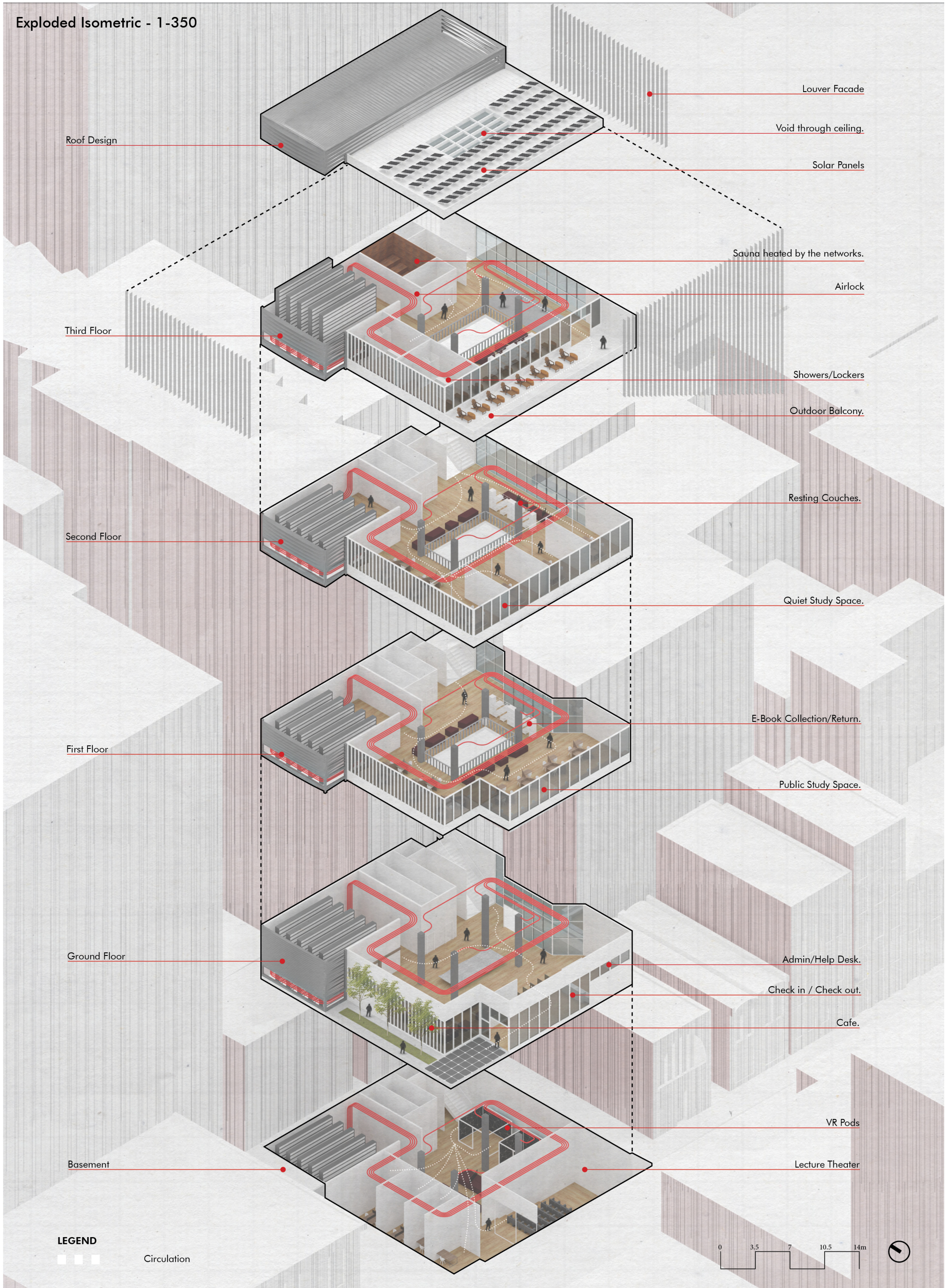

LIBRARY OF THE FUTURE

A NETWORK OF THINGS

04

THE PLAN

Ground Floor Plan - 1-200

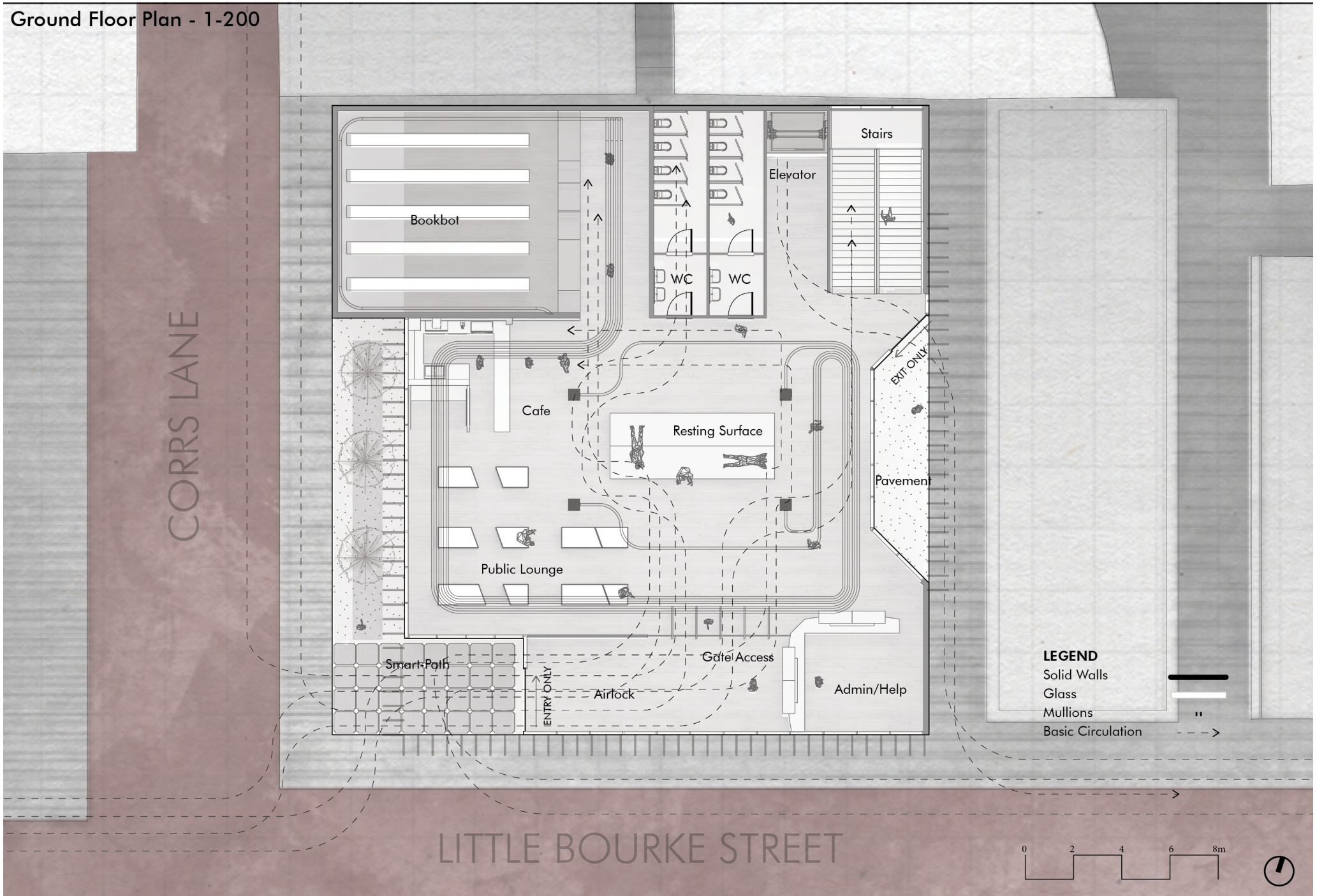

First Floor Plan - 1-200



LIBRARY OF THE FUTURE

A NETWORK OF THINGS

05

THE PLAN

Second Floor Plan - 1-200

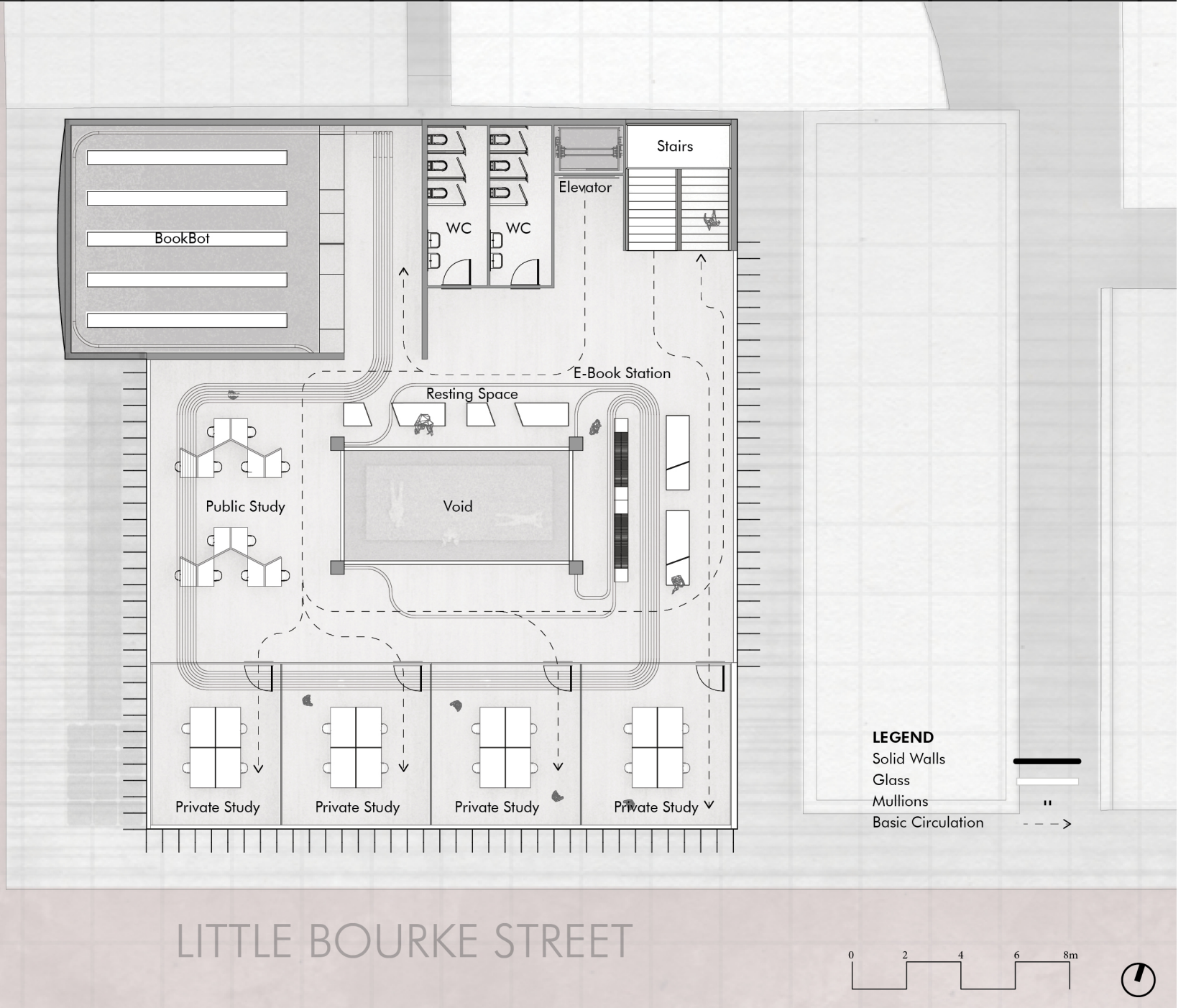

Third Floor Plan - 1-200

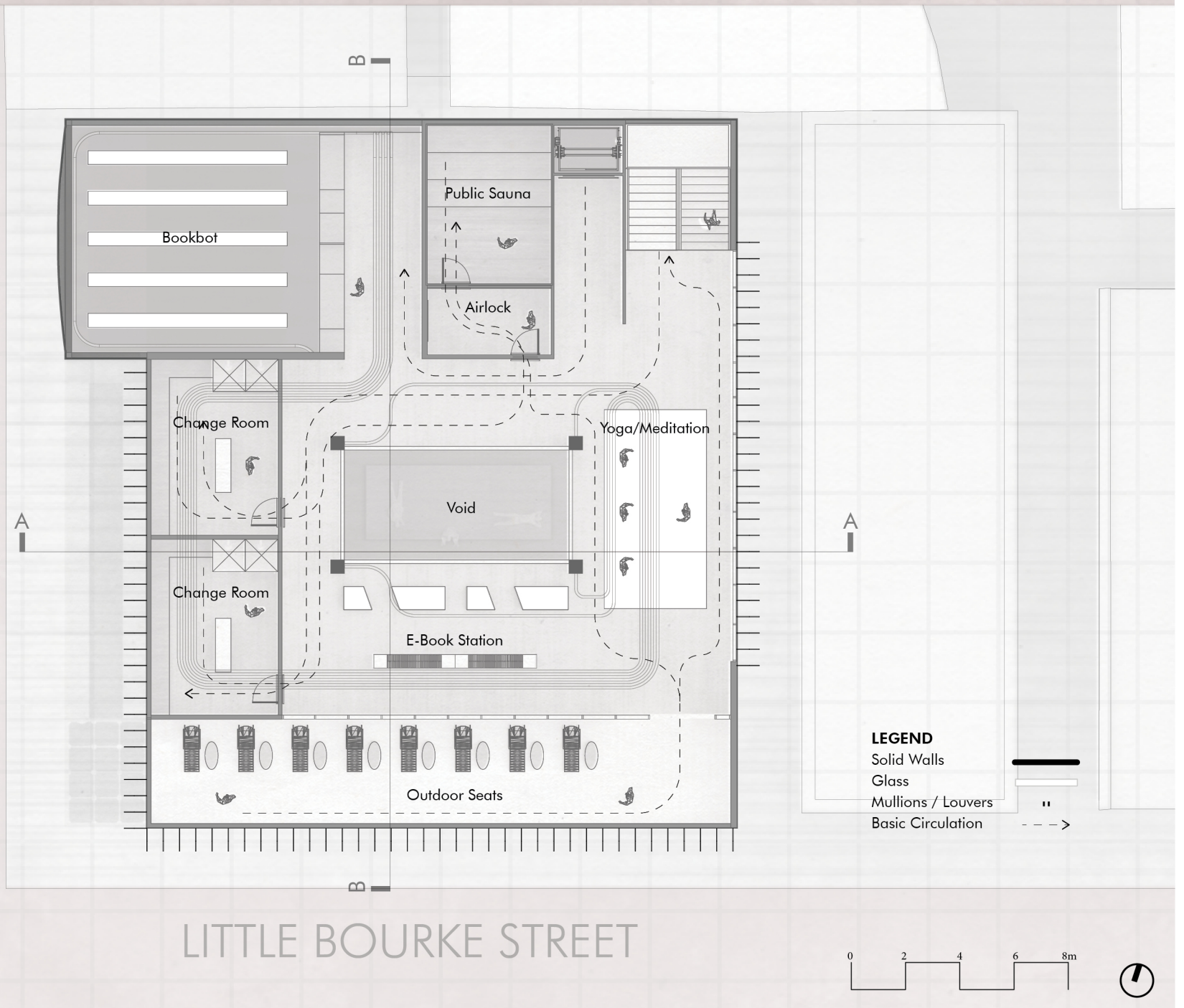

LIBRARY OF THE FUTURE

A NETWORK OF THINGS

06

THE SECTION

Section AA - 1-200



Section BB - 1-200



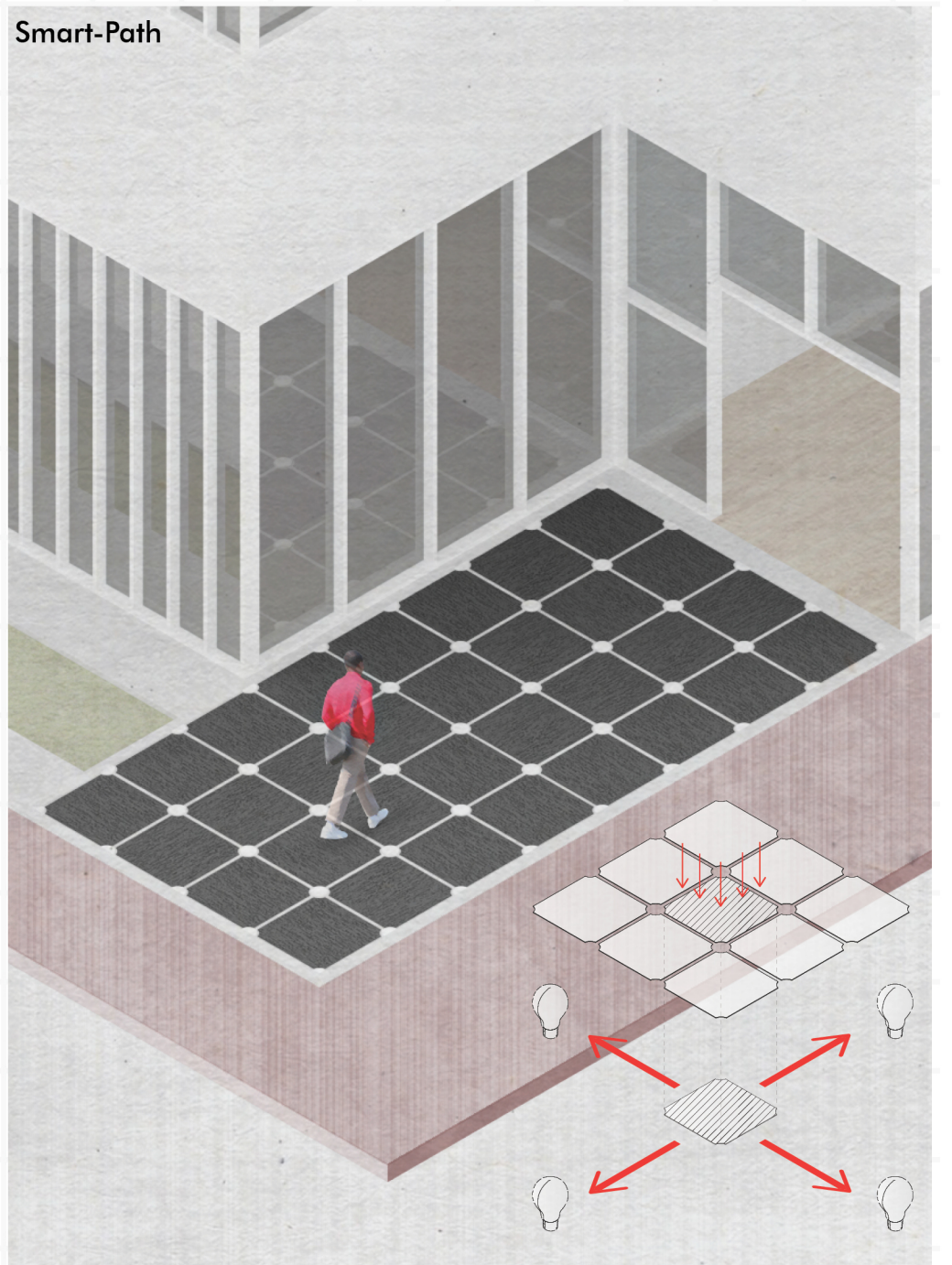
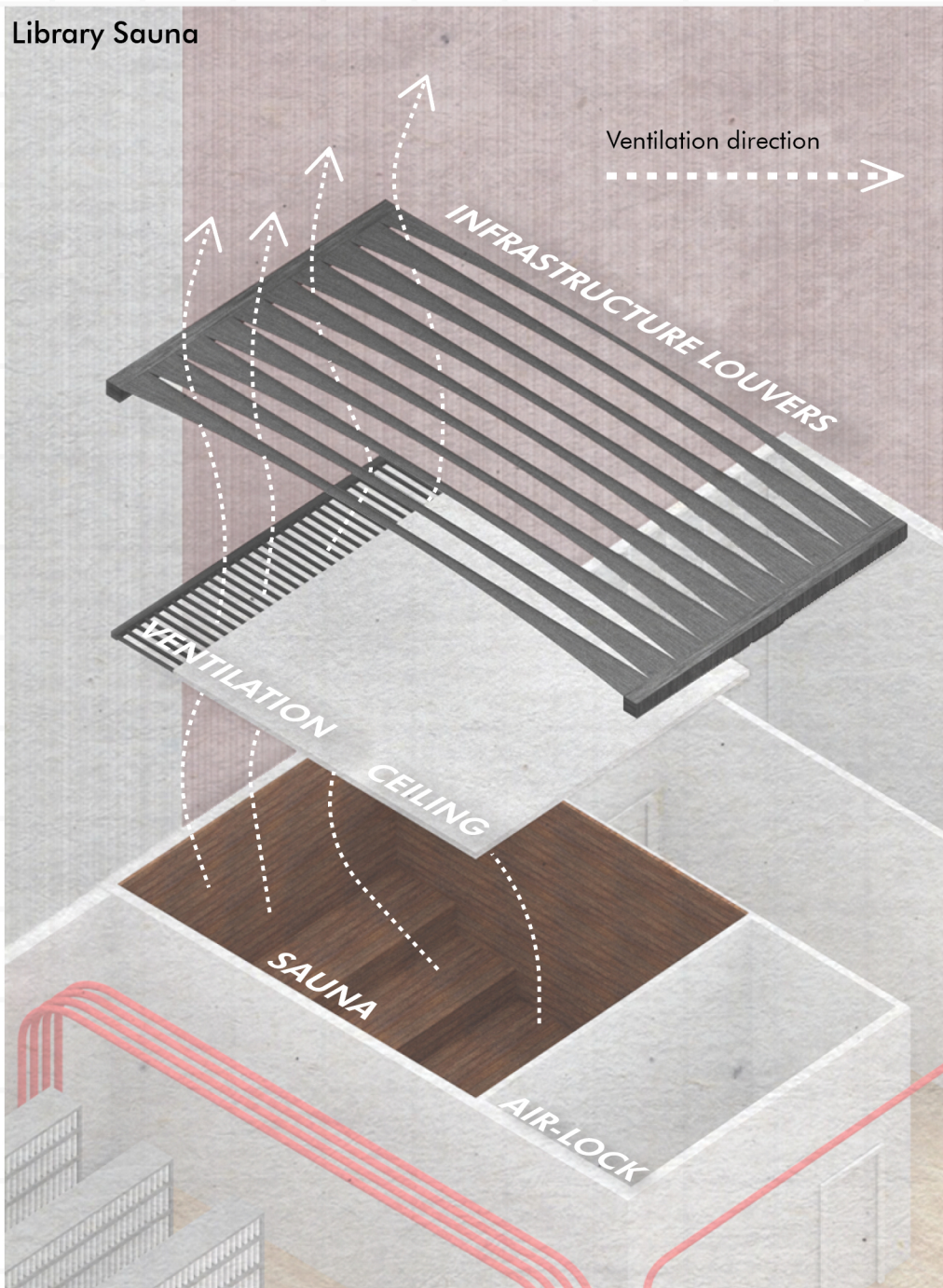
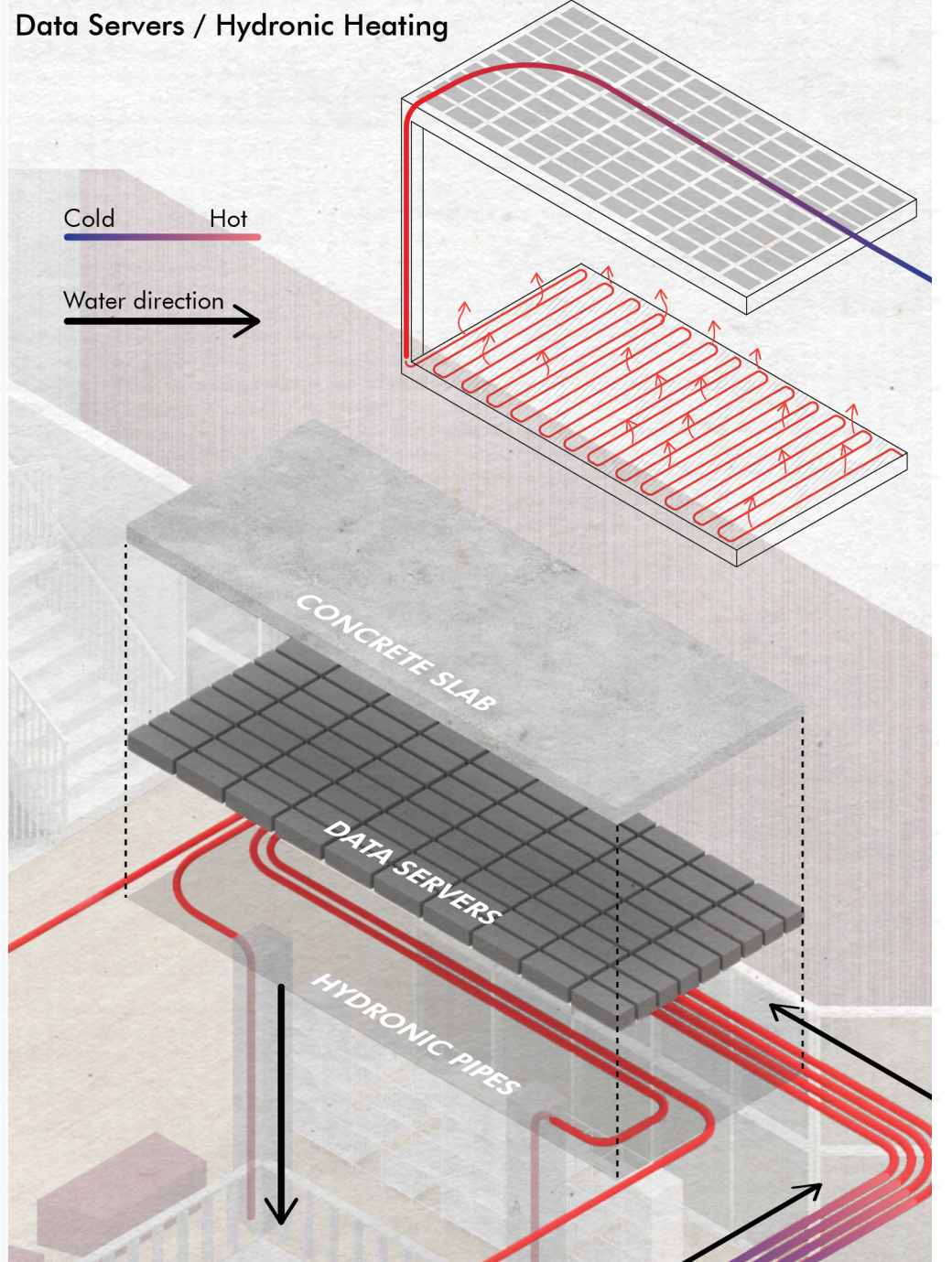
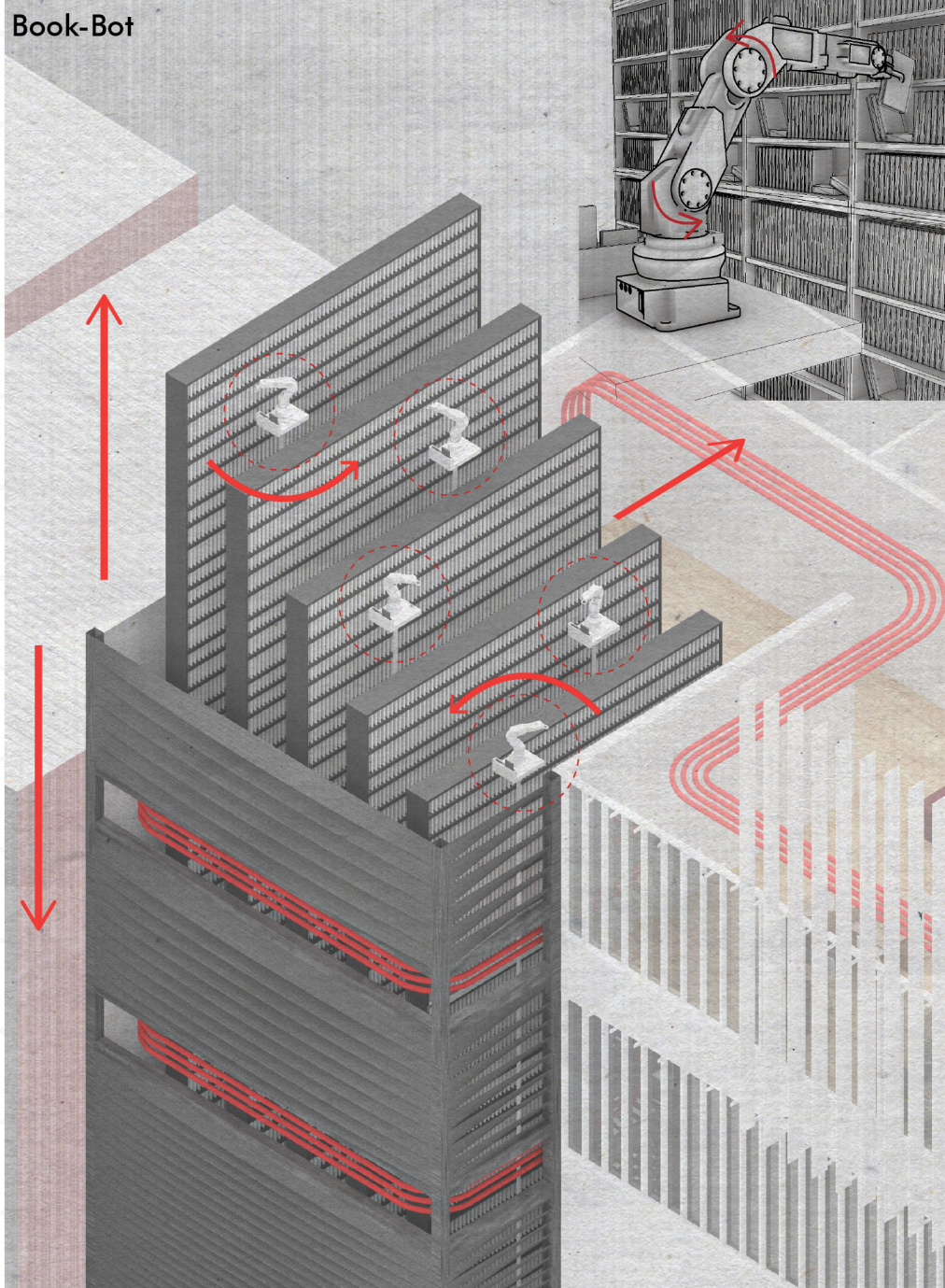

A view of the building from Little Bourke Street.



A ground floor view looking up into the skylight roof atrium.

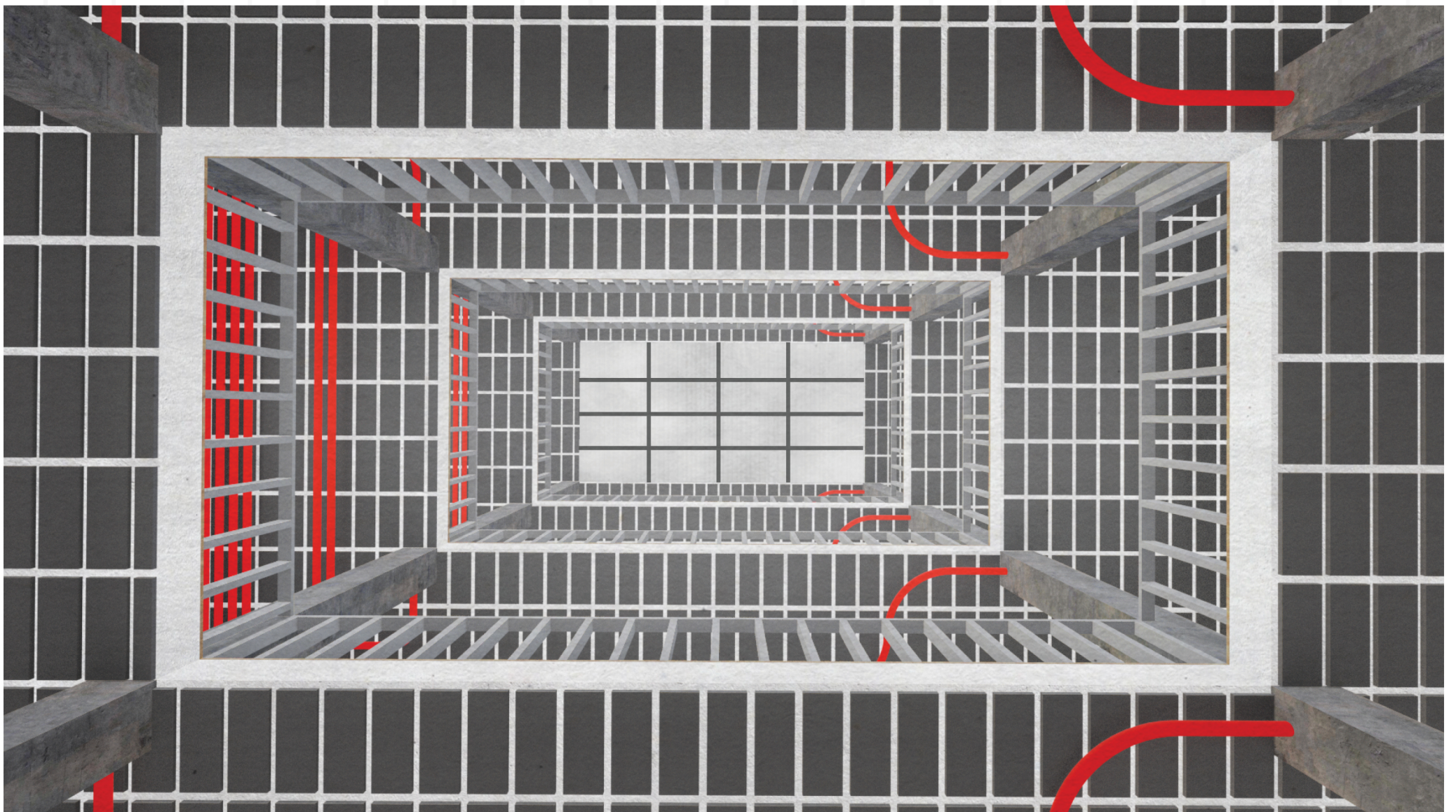

A view from level 01 of the building.



A view inside the library sauna generated by the thermal heat technology.

